MIX & MINGLE

CHIPS & HOUSEMADE DIP PLATTERS

SERVES 12 PEOPLE

SALSA - \$15

GUACAMOLE - \$18

HUMMUS - \$20

SPINACH ARTICHOKE DIP - \$21

HOT HOR D'OEUVRES

MINI CHICKEN SATAY SKEWERS	12•\$30	24•\$60
MINI BEEF SATAY SKEWERS	12•\$30	24•\$60
MINI SHRIMP SATAY SKEWERS	12•\$35	24•\$70
BLACKSTONE SLIDERS	12•\$30	24•\$60
MINI CHICKEN FINGERS	12•\$30	24•\$60
SHRIMP BOULETTES	12•\$15	24•\$30
PROSCIUTTO WRAPPED ASPARAGUS	12•\$30	24•\$60
BACON WRAPPED SCALLOPS	12•\$35	24•\$70
GARLIC SPINACH STUFFED MUSHROOMS	12•\$18	24•\$36

DECORATIVE PLATTERS

SERVES 12 PEOPLE

BRUSCHETTA - \$18

FRESH VEGETABLES - \$25

FRESH FRUIT SKEWERS - \$30

SEARED AHI TUNA CRISPS - \$30

CAPRESE SALAD - \$25

CRÈME BRULÉE

12•\$36 24•\$72

CHOCOLATE DECADENCE CAKE PLATTER

12•\$35 24•\$70

CHOCOLATE GANACHE CUPCAKES

12•\$30 24•\$60



BUFFET MENU

SALADS

BLACKSTONE

CAESAR

GREEK

CITRUS

SIDES

GARLIC SMASHED POTATOES

AU GRATIN POTATOES

BLACKSTONE POTATOES

MAC & CHEESE

MIAGGI BEANS

VEGETABLE STIR FRY

ENTREES

PRIME RIB

VILLA SIRLOIN

HONEY CHIPOTLE CHICKEN

MEDITERRANEAN CHICKEN

IOWA PORK CHOP

ROASTED SALMON

MEDITERRANEAN PASTA

FLYNN'S BAKED PASTA

DESSERT

ASSORTED SWEET SPOTS

SELECT THREE ENTREES, TWO SIDES
AND TWO SALAD OPTIONS - **\$27**

SELECT TWO ENTREES, TWO SIDE CHOICES
AND ONE SALAD OPTION - **\$22**



PLATED MENU

SALADS

PLEASE SELECT TWO OF THE FOLLOWING SALAD OPTIONS

BLACKSTONE
CAESAR
GREEK
CITRUS

SIDES

PLEASE SELECT TWO OF THE FOLLOWING SIDE OPTIONS

GARLIC SMASHED POTATOES
BLACKSTONE POTATOES
MAC & CHEESE
MIAGGI BEANS
VEGETABLE STIR FRY
FRENCH ONION SOUP

ENTREES

PLEASE SELECT THREE OF THE FOLLOWING OPTIONS

PRIME RIB
VILLA SIRLOIN
HONEY CHIPOTLE CHICKEN
MEDITERRANEAN CHICKEN
IOWA PORK CHOP
ROASTED SALMON
MEDITERRANEAN PASTA
FLYNN'S BAKED PASTA

DESSERTS

PLEASE SELECT ONE OF THE FOLLOWING DESSERT OPTIONS

CHOCOLATE GANACHE CUPCAKES
ASSORTED SWEET SPOTS

CUSTOM MENUS WILL DISPLAY YOUR
SELECTIONS FOR GUESTS TO ORDER
FROM. BOTH SIDE SELECTIONS
WILL BE FEATURED WITH EACH
ORDERED ENTRÉE - **\$29**



CLUB ROOM

OUR MOST INTIMATE SPACE SEATS UP TO 30 GUESTS, PERFECT FOR SMALL GATHERINGS AND BUSINESS MEETINGS. THIS ELEGANT ROOM ALSO FEATURES A 60" PLASMA TV, BUILT IN WINE RACK, AND GRANITE COUNTER IDEAL FOR ENTERTAINING.

SELECT MENUS

MIX & MINGLE

PLATED

MINIMUMS

SUN-THURS – ALL NIGHT

\$500.00

FRI & SAT – ALL NIGHT

\$750.00

SCENARIO #1

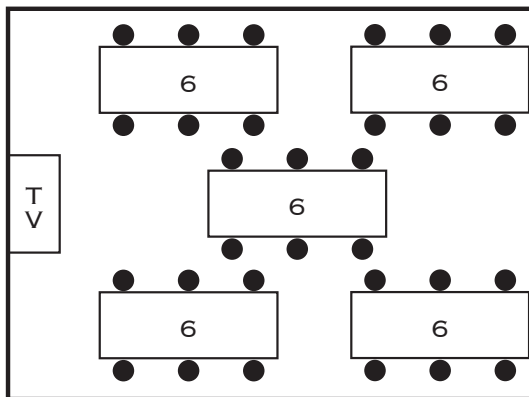

* More configurations on back



SCENARIO #2

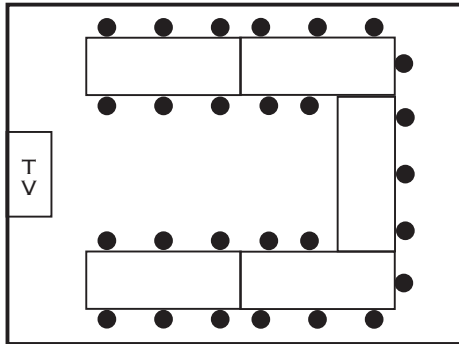

SCENARIO #3

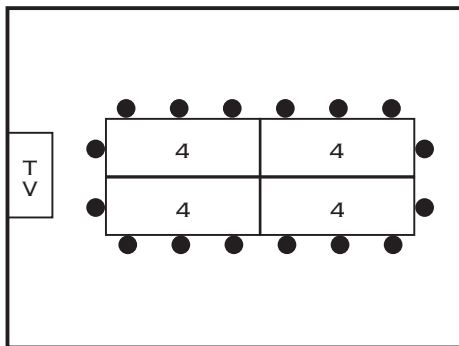

CHICAGO ROOM

OUR LARGEST PRIVATE DINING ROOM SEATS UP TO 60 GUESTS. THIS WARM AND WELCOMING ROOM FEATURES A FIREPLACE AND A 50" PLASMA TV.

SCENARIO #1

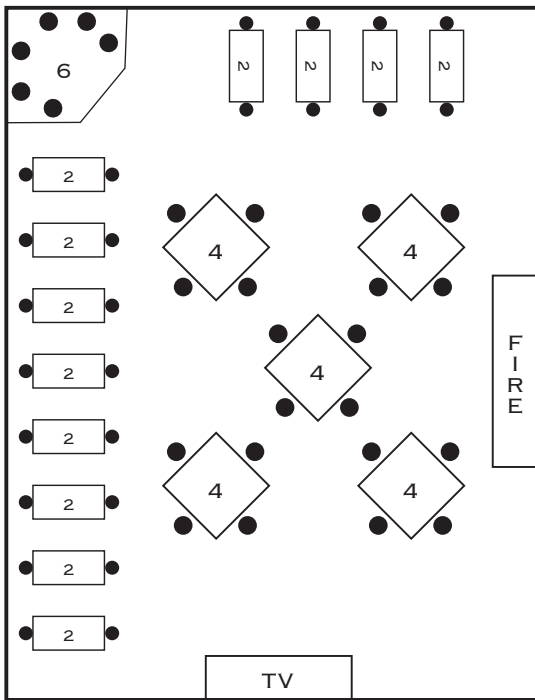

SELECT MENUS

MIX & MINGLE
PLATED
BUFFET

MINIMUMS

SUN - WED
\$500.00

THURS
\$750.00

FRI & SAT
5:00 – 7:30
\$1,500
8:00 – CLOSE
\$1,500

ALL NIGHT
\$2,000

* More configurations on back



SCENARIO #2

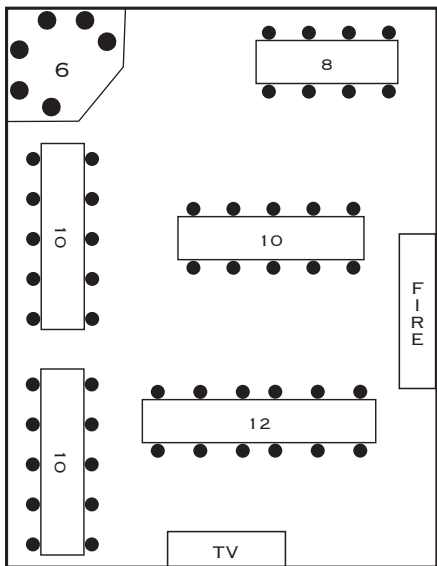

SCENARIO #4

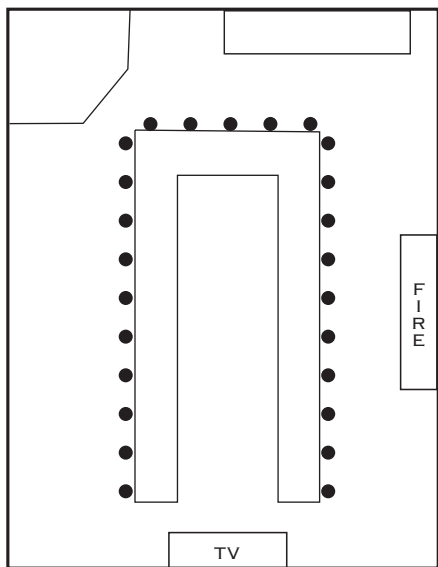

SCENARIO #3

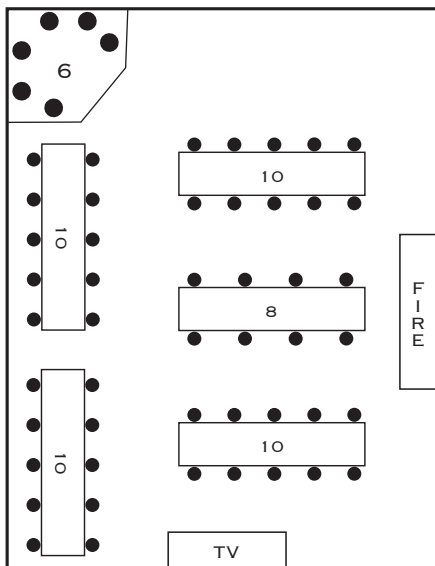

FINISHING TOUCHES

PRIVATE BAR

ENJOY YOUR OWN PORTABLE AND PRIVATE BAR,
STOCKED AS YOU WISH
SET UP FEE \$50

BOTTLES & BUBBLY

ASSORTED WHITE, RED & CHAMPAGNE
PRICE VARIES BY BOTTLE

DECORATIONS

TAKE YOUR EVENT TO THE NEXT LEVEL!
WE CAN SUPPLY:
LINENS • FLOWERS • BALLOONS • ETC

